

NOTE: FOR MORE DETAILS SEE YOUR V.P. CUSTOMER SERVICE REP.

REVISIONS			
REV.	DESCRIPTION	DATE	APPROVED
A	INITIAL RELEASE	04-12-02	
B	CO 039 Drafting Update	05-08-06	Rick C.

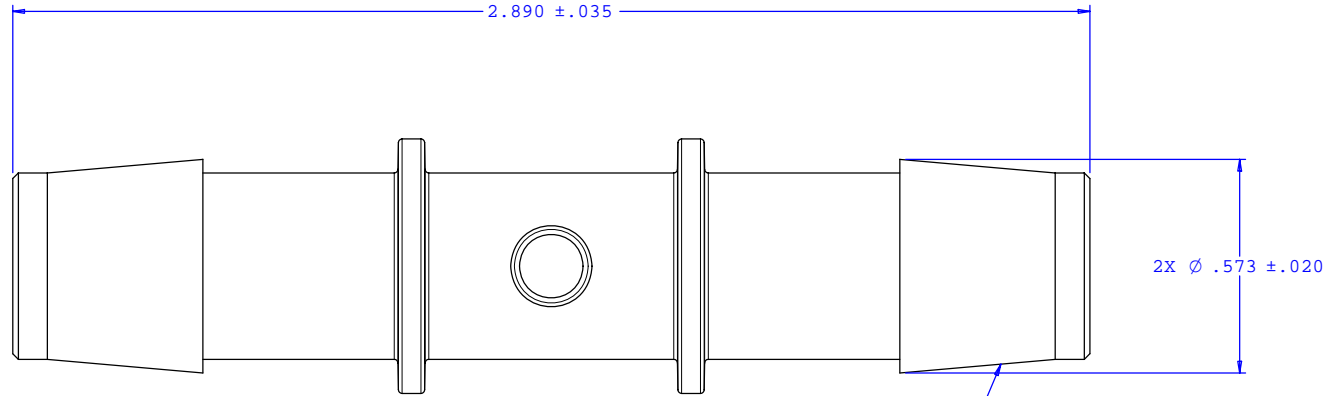

2X INSTRUMENT QUALITY PART. NO PARTING LINE PERMITTED ON THIS CONICAL SURFACE

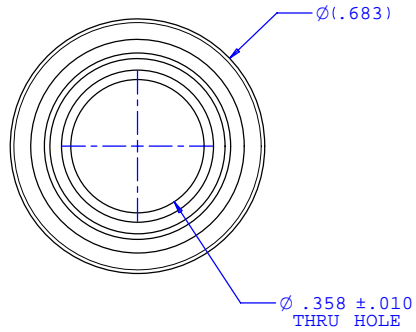
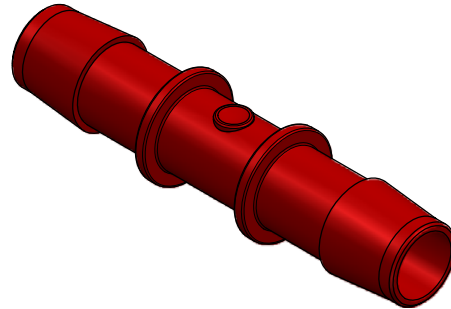

UNLESS OTHERWISE SPECIFIED DIMENSIONS ARE IN INCHES TOLERANCES ARE:		VALUE PLASTICS, INC.	
FRACTIONS ±	DECIMALS .XX ±.01 .XXX ±.005 .XXXX ±.001	ANGULAR ±1°	PART NUMBER: N975
DO NOT SCALE DRAWING		DESCRIPTION: Straight Through Connector with 900 Series Barbs, 1/2" (12.5 mm) ID Tubing	
DRAWN BY: Frank Lombardi	DATE: 01-21-06	SIZE: B	SCALE: NTS
ENGINEER/ MANAGER: Rick Cairns	DRAWING NUMBER: 1008156	REV. B	SHEET: 1 OF 1
		© 2005 VALUE PLASTICS, INC.	

FOR REFERENCE ONLY